



**Piazza del Carmine 12, PT**

**Tel. 0573/528161**

**Mail: [ozonesistempistoia@gmail.com](mailto:ozonesistempistoia@gmail.com)**

**IMPIANTI SU PREVENTIVO**

# Nebulizzazione dell'acqua

**Che cos'è la nebulizzazione dell'acqua:** attraverso una pompa si porta la pressione dell'acqua a 60bar ed attraverso degli speciali ugelli si nebulizza in milioni di goccioline che vengono immesse nell'ambiente desiderato.

La nebulizzazione dell'acqua controllata, non bagna, non è dannosa per l'uomo e viene utilizzata per molteplici applicazioni.

**Si realizzano impianti su progetto, personalizzati e chiavi in mano.**

Siamo in grado di fornire e realizzare impianti per la gestione da 1 a 16 zone contemporaneamente personalizzando ogni zona (pausa-lavoro nebulizzazione e % umidità all'interno delle singole zone)

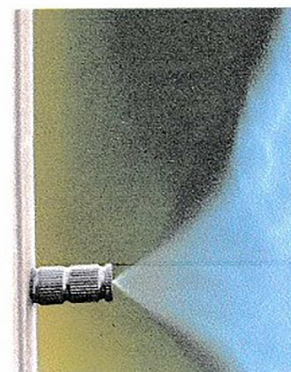

La nebulizzazione dell'acqua ed i suoi utilizzi:

- Umidificazione controllata
- Abbattimento polveri
- Abbattimento odori
- Abbattimento temperatura

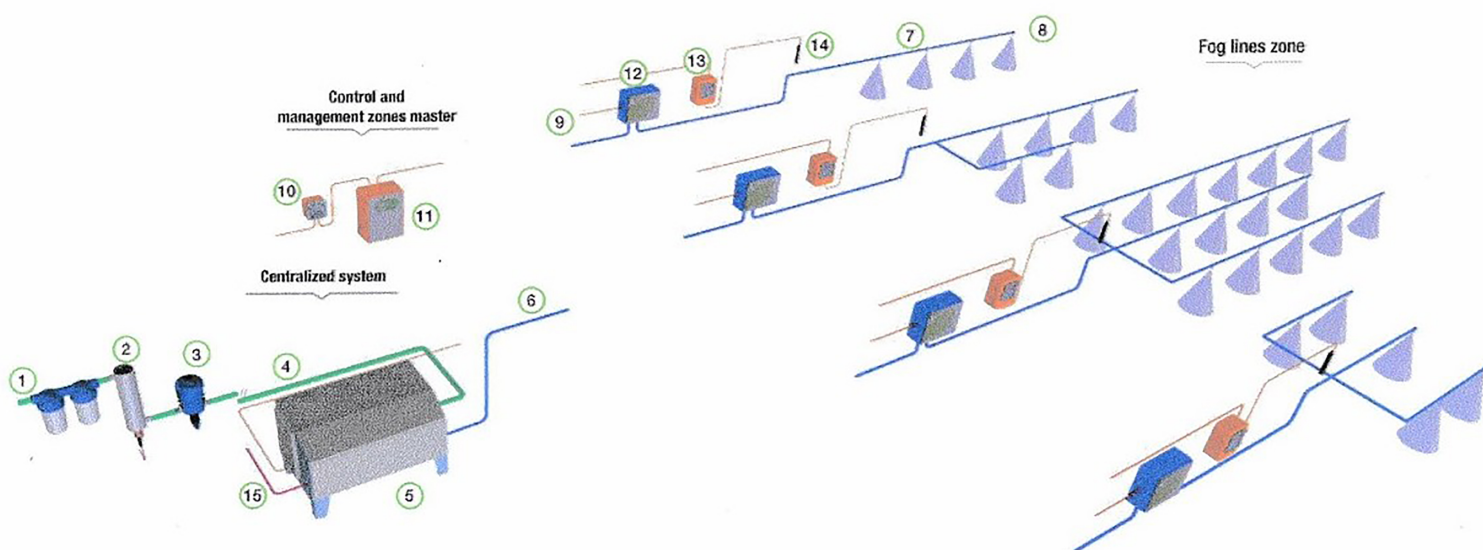
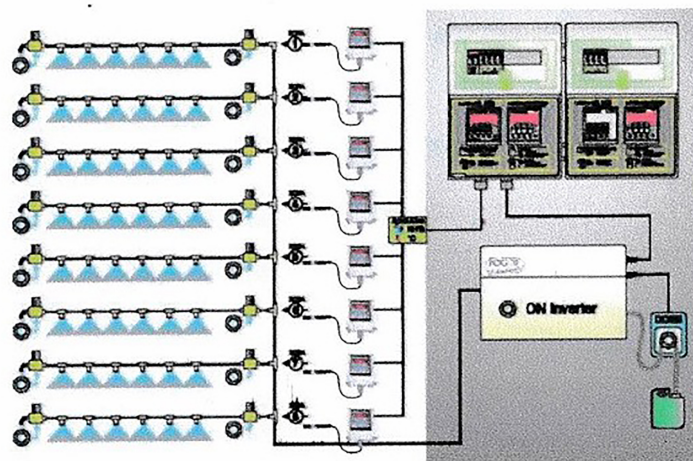

## Abbattimento Polveri Centro compostaggio Carta e Cartone

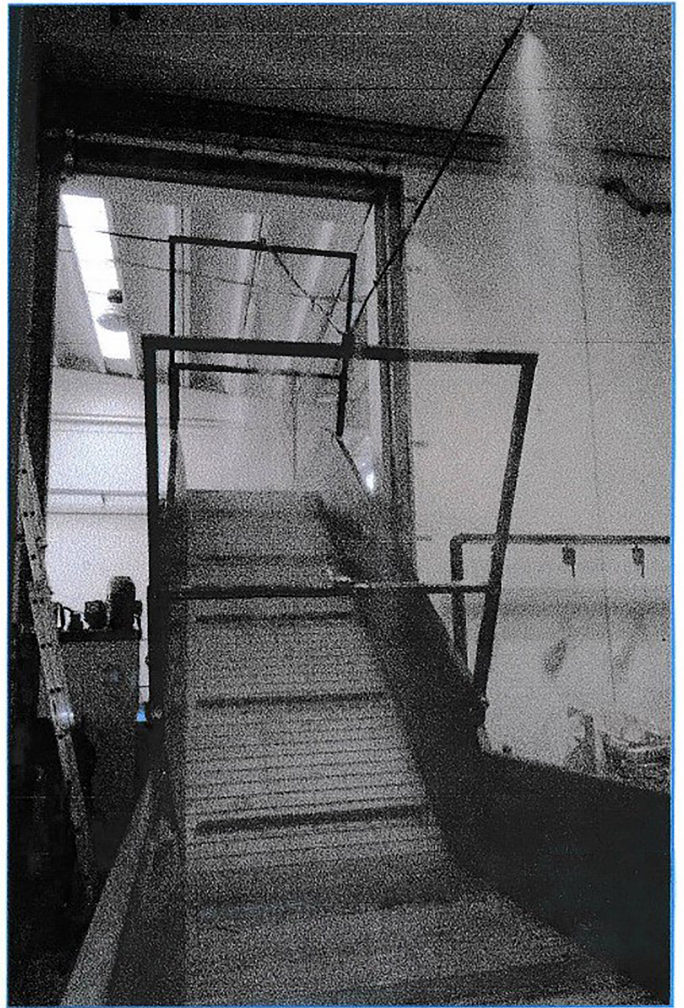

## Umidificazione controllata Filatura

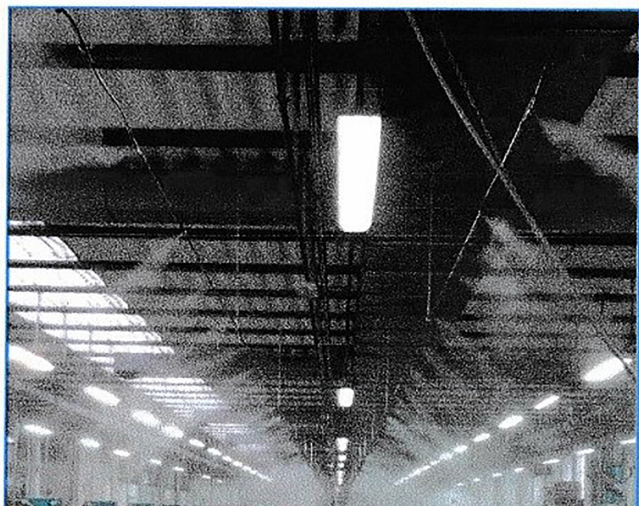
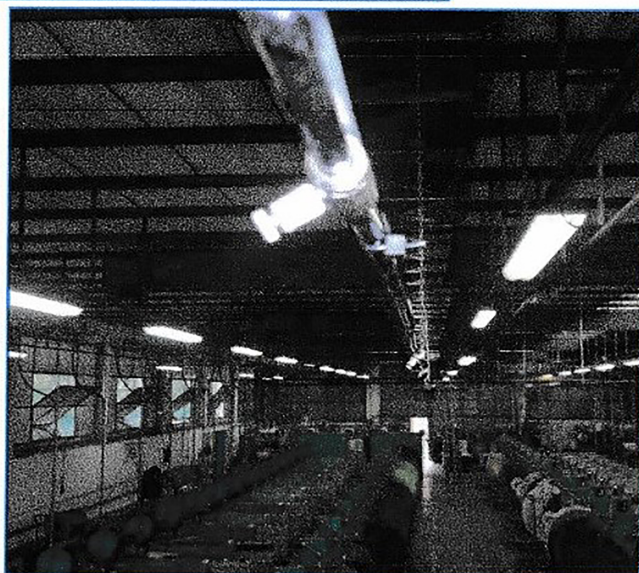
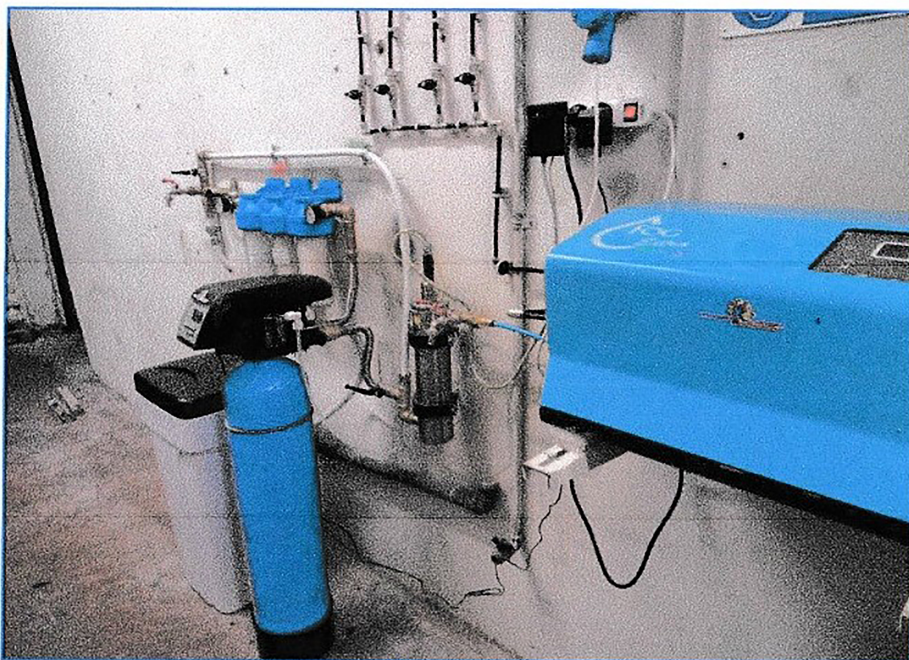

### Raffrescamento naturale Concessionaria



Umidificazione controllata / abbattimento polveri Roccatura

